

LP3500TM

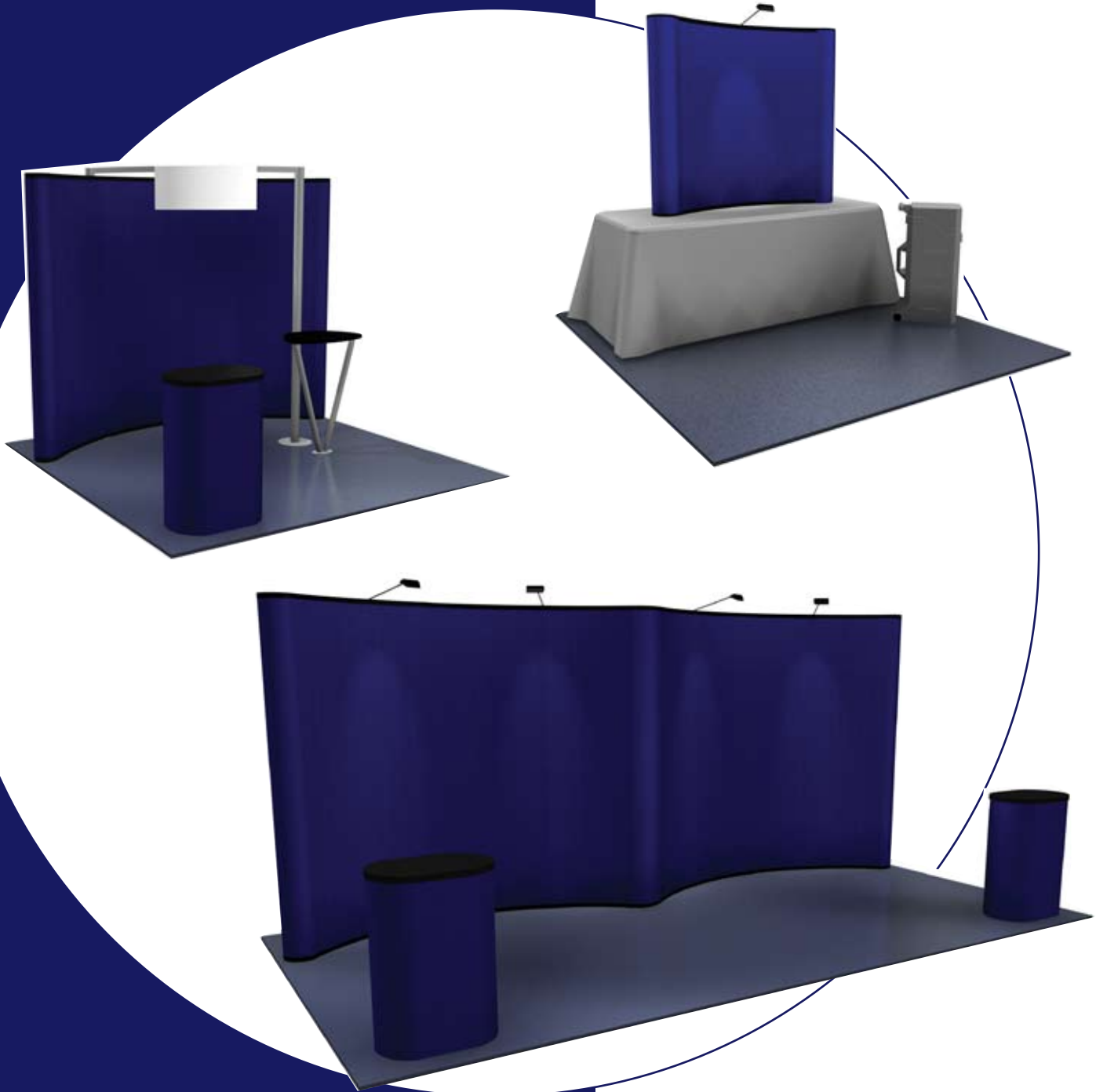

TIDELINE[®]
Design

LP3500TM
Catalog
2008-2009
11/7/08

INFORMATION

General Information..... 3

KITS

Tabletop Kits..... 4
8' Kits..... 7
10' Kits..... 8
10' x 20' Kits.....14

PARTS AND ACCESSORIES

Curved frames.....17
Straight frames.....17
Channel bars and stiffeners.....18
Panels, (curved and straight).....19
Round endcaps.....19
Flatendcaps.....19
Connector Panels.....19
Shelving, Miscellaneous items.....20
Headers.....20
Lighting.....20

Shipping cases.....21

COUNTERS

Counters and countertops.....21

Production Time:

Standard production time: 5 business days from receipt of purchase order for stock colors, 10 business days for non-stock colors. Rush charges may apply for shorter lead times.

*Quick Ship: Coming soon. Contact Dealer Support for details.

Stock Colors:

Velcro® receptive ribbed fabric colors are:

Royal Blue – PMS 281C

Blue – PMS 287C

Red – PMS 187C

Silver – PMS 429U/430U

Charcoal – PMS 424C

Black – PMS Black 6C 2X

*Note: Non-stock colors are available & require a lead time of 10 business days from receipt of purchase order.

Standard Laminate:

Standard laminate finish for Case-to-Counter Conversion countertops is Formica #909-58 Black Matte. Other colors available upon request for additional \$50.00 (net) cost, and require a lead time of 10 business days from receipt of purchase order.

Accessories:

LP3500 has a full range of accessories including shelving, lighting, backlit headers, and independent counters.

Quad Description:

This catalog will always refer to frames in numbers of quads high by number of quads wide. For example a 2 x 3 quad frame will mean that the frame is 2 quads high by 3 quads wide.

Dimensional Weight:

If the cubic size of a package exceeds a carriers' size allowance, the dimensional weight system is used. Dimensional weight calculates the volumetric weight of packages. Freight carriers then utilize the greater of the actual weight or dimensional weight to invoice shipping charges. Domestic air & ground shipments are calculated as (Length x Width x Height) divided by 194, with all dimensions in inches. For international freight, dimensional weight is calculated as (Length x Width x Height) divided by 166.

Returns:

All returns to TideLine Design, Inc., whether warranty work or not, must have a "Return Authorization Number" that has been issued by Dealer Support Services, and must be shipped freight "pre-paid" by dealer or end-user. Shipments received without an RA-number may be refused and sent back to shipper at shipper's expense.

Warranty:

TideLine Design's mission is to provide its dealers with the highest quality products and services. LP3500 frames & channel bars have a "no questions asked" guarantee & are warranted for the life of the product. All other components are warranted to be free from defects in workmanship and materials for 90 days from shipment of product. These warranties apply to original purchaser only & do not cover components that have been modified, altered, or repaired by anyone other than TideLine Design, Inc.

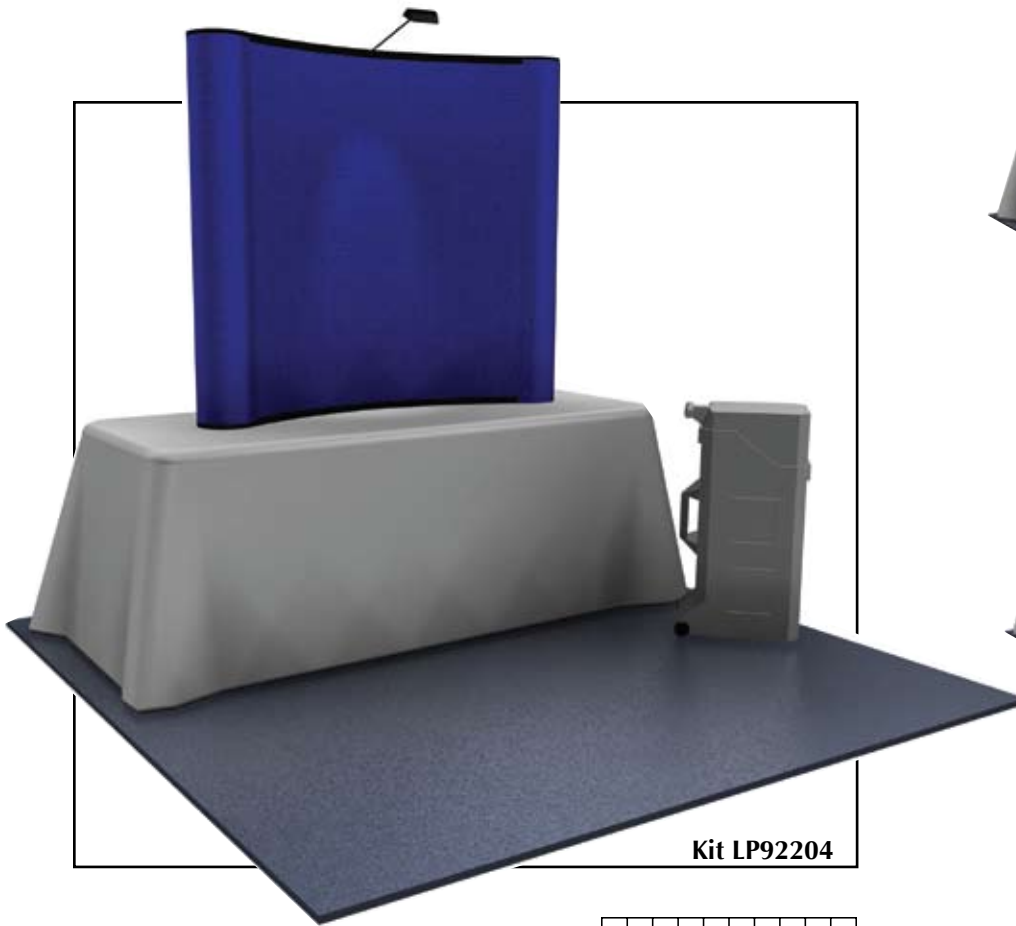

Kit LP92204

Dimensions

6'w x 63"h x 13"d

Weight

42 lbs.

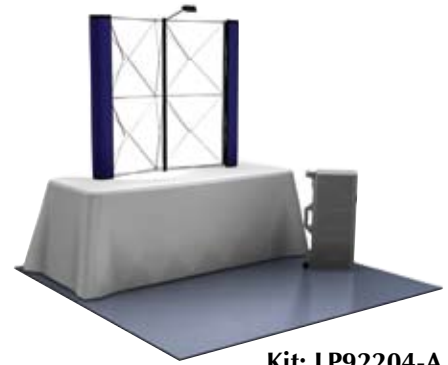
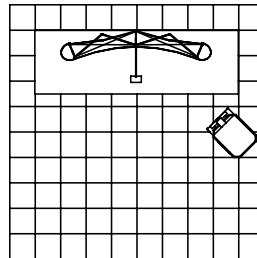

Kit: LP92204-A
Fabric Endcaps



Kit: LP92204-B
Fabric Endcaps



Kit: LP92204-C
Fabric Endcaps



Kit: LP92204-CE
Fabric Endcaps

Qty.	Part SKU#	Kit LP92204	Item Weight
1	LP4004	2x2 quad curved frame	4.00
5	LP2004	Connected channel bars	1.20
2	LP3102	Curved front fabric panels	3.00
2	LP3122	Fabric endcaps	2.00
1	LP8003	Halogen 150-watt lights	1.70
1	WSC7001	Square case w/wheels & handle	18.00

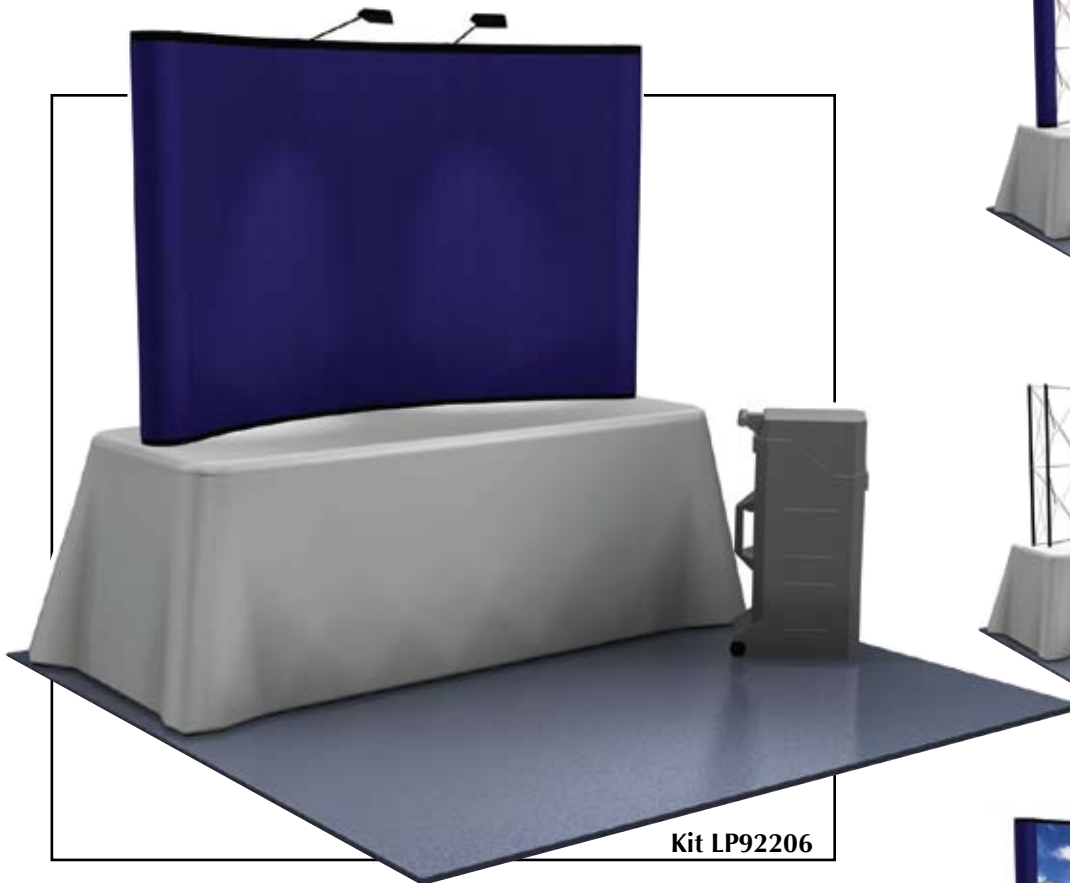

Kit LP92206



Kit: LP92206-A
Fabric Endcaps



Kit: LP92206-B
Frame Only



Kit: LP92206-C
Photo Mural &
Fabric Endcaps



Kit: LP92206-CE
Full Photo Mural

Dimensions

8'w x 63"h x 20"d

Weight

47 lbs.

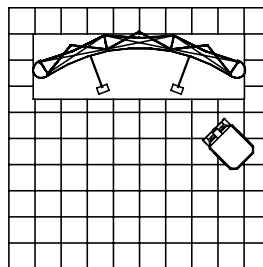

Qty.	Part SKU#	Kit LP92206	Item Weight
1	LP4006	2x3 quad curved frame	6.00
6	LP2004	Connected channel bars	1.20
3	LP3102	Curved front fabric panels	3.00
2	LP3122	Fabric endcaps	2.00
2	LP8003	Halogen 150-watt lights	1.70
1	WSC7001	Square case w/wheels & handle	18.00



Kit LPR92206



Kit: LPR92206-A
Fabric Endcaps



Kit: LPR92206-B
Frame Only



Kit: LPR92206-C
Photo Mural &
Fabric Endcaps



Kit: LPR92206-CE
Full Photo Mural

Dimensions

6'5" w x 50" h x 16" d

Weight

48 lbs.

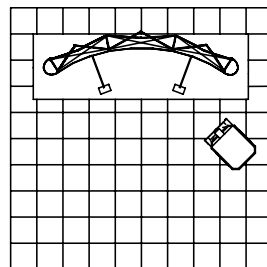

Qty.	Part SKU#	Kit LPR92206	Item Weight
1	LPR4006	2x3 reduced quad curved frame	5.00
6	LPR2004	Connected channel bars	1.20
3	LPR3102	Curved front fabric panels	
3.00			
2	PR3122	Fabric endcaps	2.00
2	LPR8003	Halogen 150-watt lights	1.70
1	WSC7001	Square case w/wheels & handle	18.00

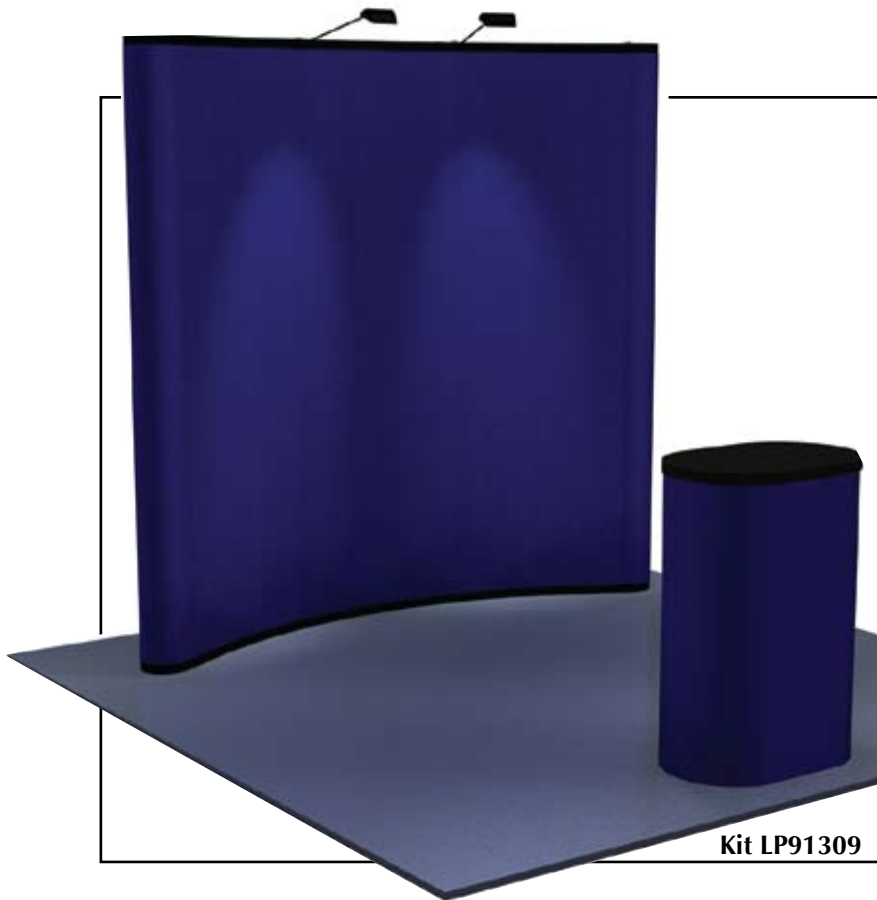

Kit LP91309



Kit: LP91309-A
Fabric Endcaps

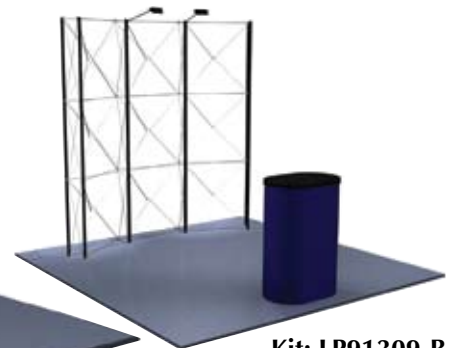

Kit: LP91309-B
Frame Only



Kit: LP91309-C
Photo Mural &
Fabric Endcaps



Kit: LP91309-CE
Full Photo Mural

Dimensions

8'w x 93"h x 20"d

Weight

65 lbs.

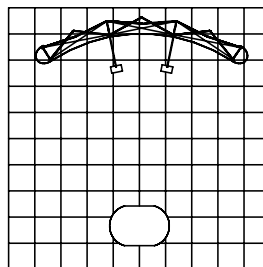

Qty.	Part SKU#	Kit LP91309	Item Weight
1	LP4009	3x3 quad curved frame	8.00
6	LP2005	Connected channel bars	1.50
3	LP3103	Curved front fabric panels	4.00
2	LP3123	Fabric endcaps	3.00
2	LP8003	Halogen 150-watt lights	1.70
1	WOC7003	Oval case w/wheels and handle	22.00
1	WOC5301	Case-to-counter kit w/fabric wrap & black Sintra inset	4.00

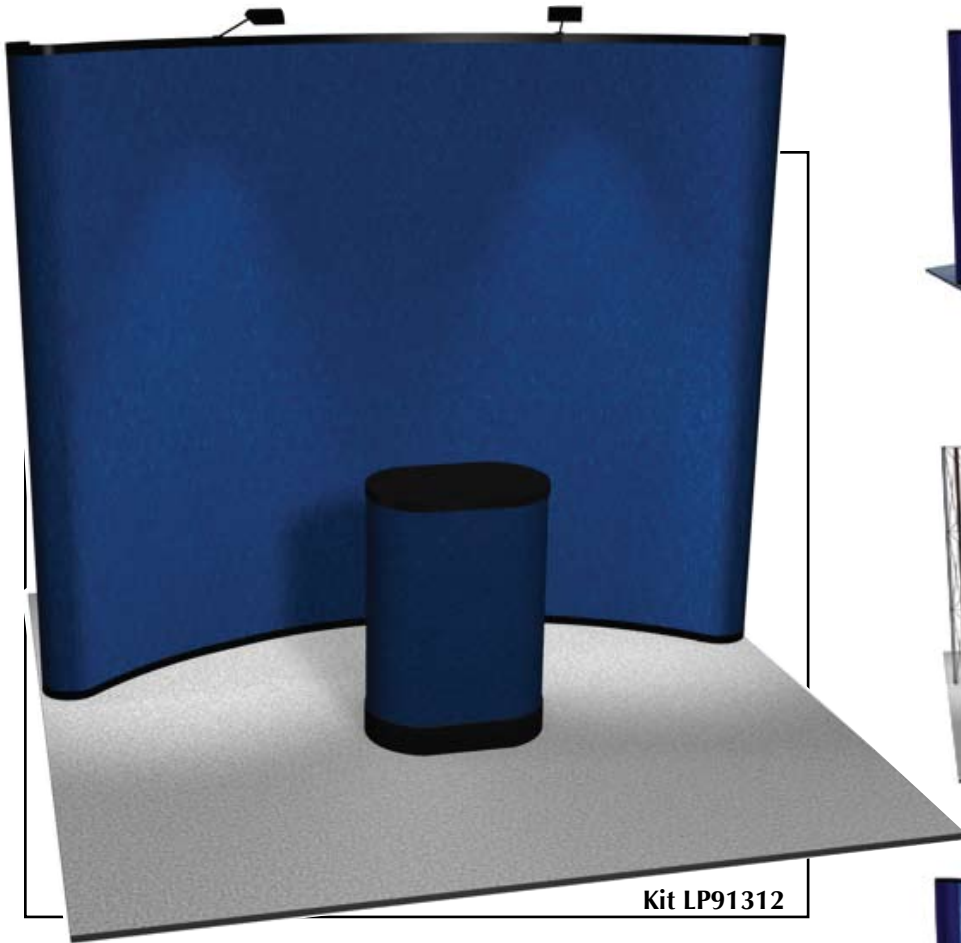

Kit LP91312



Kit: LP91312-A
Fabric Endcaps

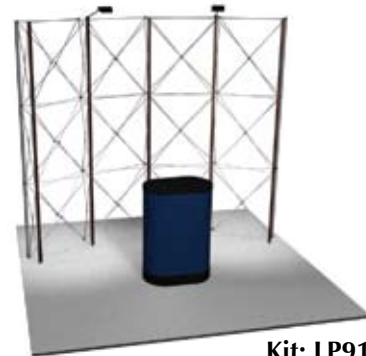

Kit: LP91312-B
Frame Only



Kit: LP91312-C
Photo Mural &
Fabric Endcaps



Kit: LP91312-CE
Full Photo Mural

Dimensions

10'w x 93"h x 31"d

Weight

74 lbs.

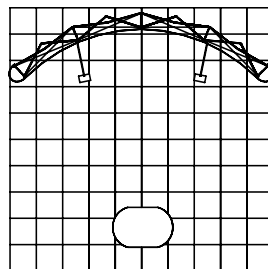

Qty.	Part SKU#	Kit LP91312	Item Weight
1	LP4012	3x4 quad curved frame	10.00
7	LP2005	Connected channel bars	1.75
4	LP3103	Curved front fabric panels	4.00
2	LP3123	Round fabric endcaps	3.00
2	LP8003	Halogen 150-watt lights	1..70
1	WOC7003	Oval case w/wheels & handle	22.00
1	WOC5301	Case-to-counter kit w/fabric wrap & black Sintra inset	4.00

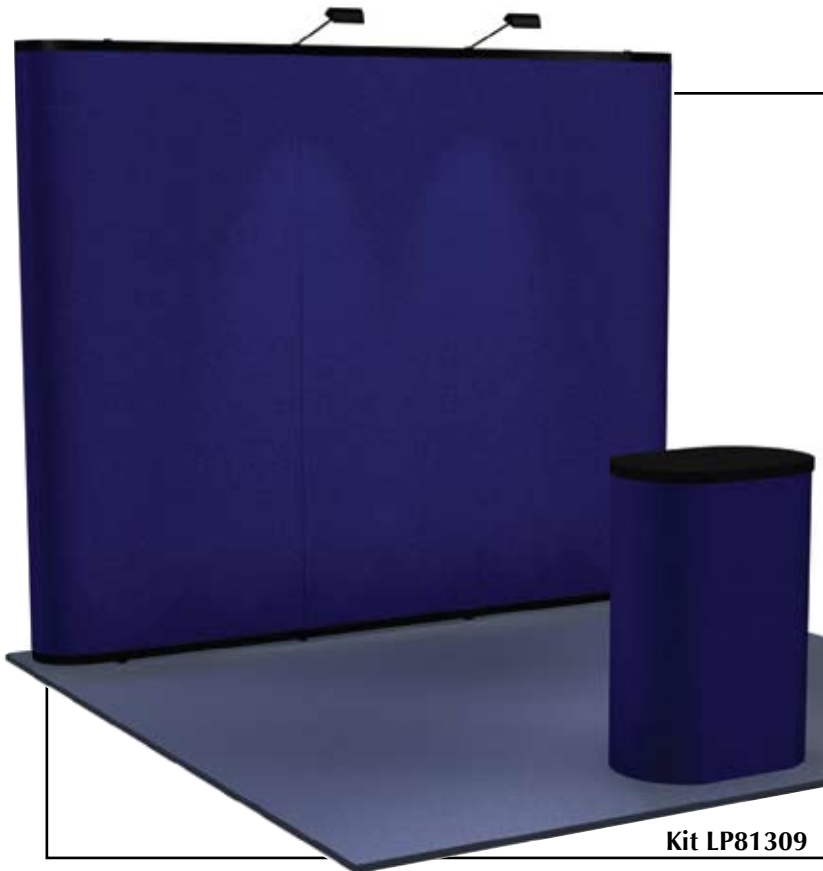

Kit LP81309



Kit: LP81309-A
Fabric Endcaps

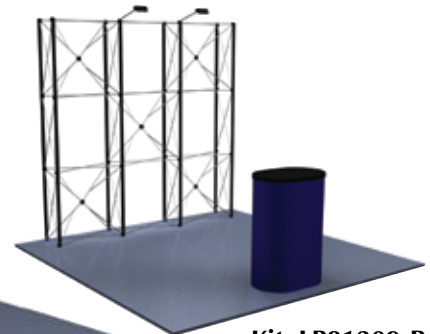

Kit: LP81309-B
Frame Only



Kit: LP81309-C
Photo Mural &
Fabric Endcaps



Kit: LP81309-CE
Full Photo Mural

Dimensions

10'w x 93"h x 13" d

Weight

66 lbs.

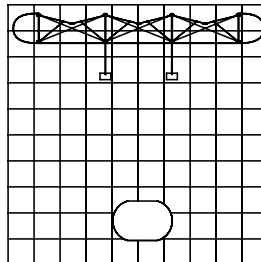

Qty.	Part SKU#	Kit LP81309	Item Weight
1	LP4809	3x3 quad straight frame	8.00
6	LP2005	Connected channel bars	1.75
3	LP3803	Straight front fabric panels	4.00
2	LP3823	Fabric endcaps	3.00
2	LP8003	Halogen 150-watt lights	1.70
1	WOC7003	Oval case w/wheels and handle	22.00
1	WOC5301	Case-to-counter kit w/fabric wrap & black Sintra inset	4.00

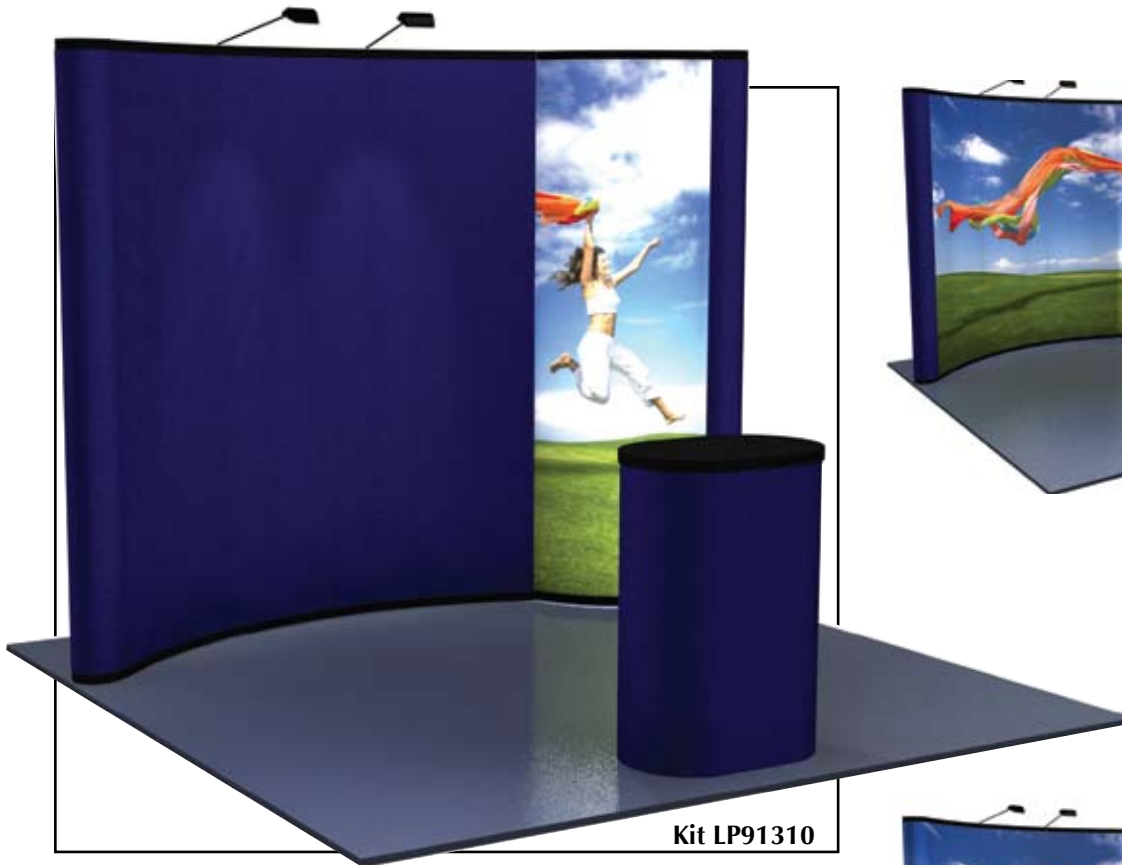

Kit LP91310



Kit: LP91310-C
Fabric Endcaps

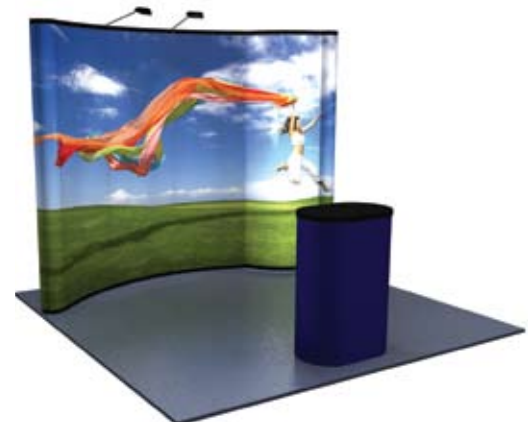

Kit: LP91310-CE
Full Photo Mural

Dimensions

10'w x 93"h x 31"d

Weight

80 lbs.

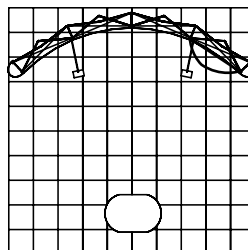

Qty.	Part SKU#	Kit LP91310	Item Weight
1	LP4012	3x4 quad curved frame	10.00
7	LP2005	Connected channel bars	1.75
3	LP3103	Curved front fabric panels	4.00
2	LP3123	Fabric endcaps	3.00
1	LP0008	Rear Lit Bubble Panel	4.00
3	30500	24" Straight Single Florescent fixture	2.00
2	LP8003	Halogen 150-watt lights	1.70
1	WOC7003	Oval Case w/wheels & handle	22.00
1	WOC5301	Case-to-counter kit w/fabric wrap & black sintra inset	4.00

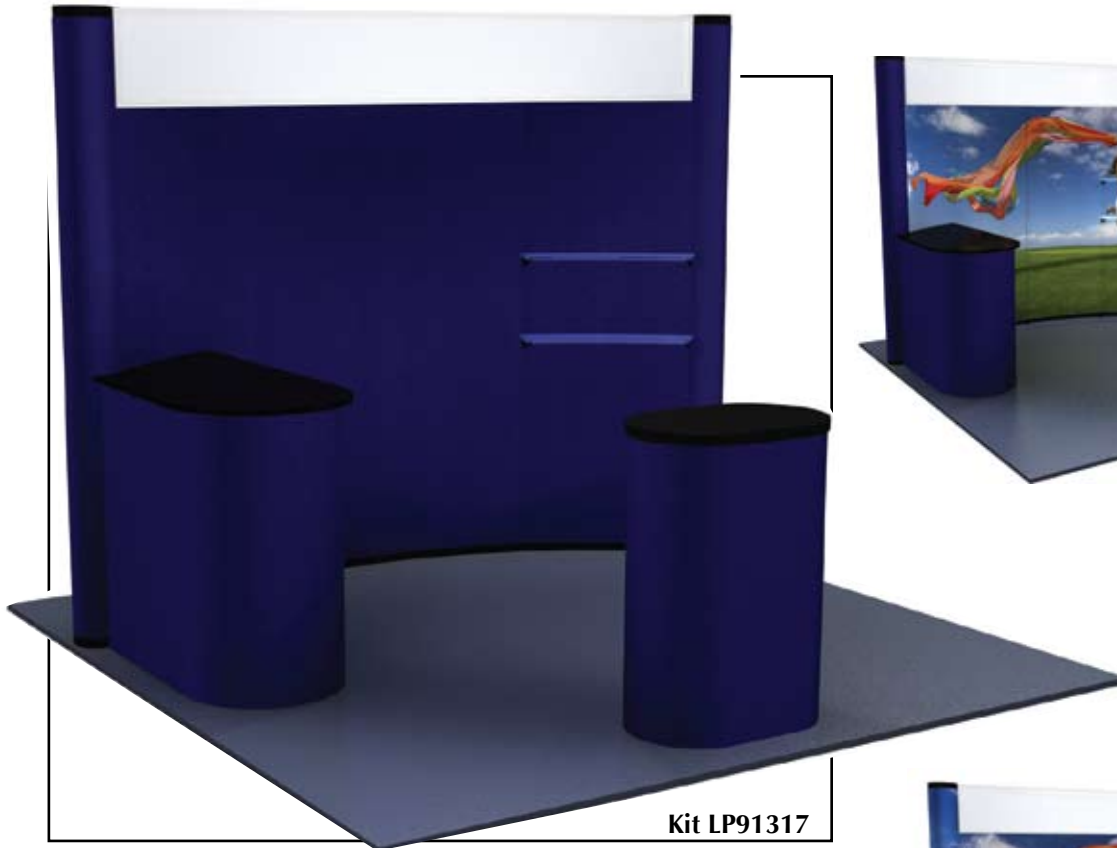

Kit LP91317



Kit: LP91317-C
Photo Mural &
Fabric Endcaps



Kit: LP91317-CE
Full Photo Mural

Dimensions

10'w x 93"h x 74"d

Weight

170 lbs.

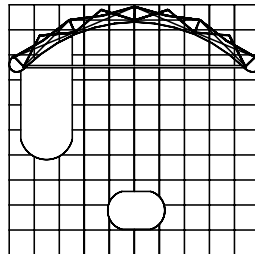

Qty.	Part SKU#	Kit LP91317	Item Weight
1	LP4012	3x4 Quad Curved Frame	10.00
7	LP2005	Connected Channel Bars	1.75
4	LP3103	Fabric Panels	4.00
2	LP3123	Fabric Endcaps	3.00
1	LP6010	10' Header Kit	10.50
1	PC0008	Left-curved Peninsula Counter w/Storage Door	53.00
2	LP5501	Standard Shelf Kits	2.00
1	WOC7003	Oval Case	22.00
1	WOC5301	Case-to-Counter Fabric Wrap & Black Sintra Inset	4.00
1	LZ0004	Wheeled Telescoping Flat Ship Case	32.00

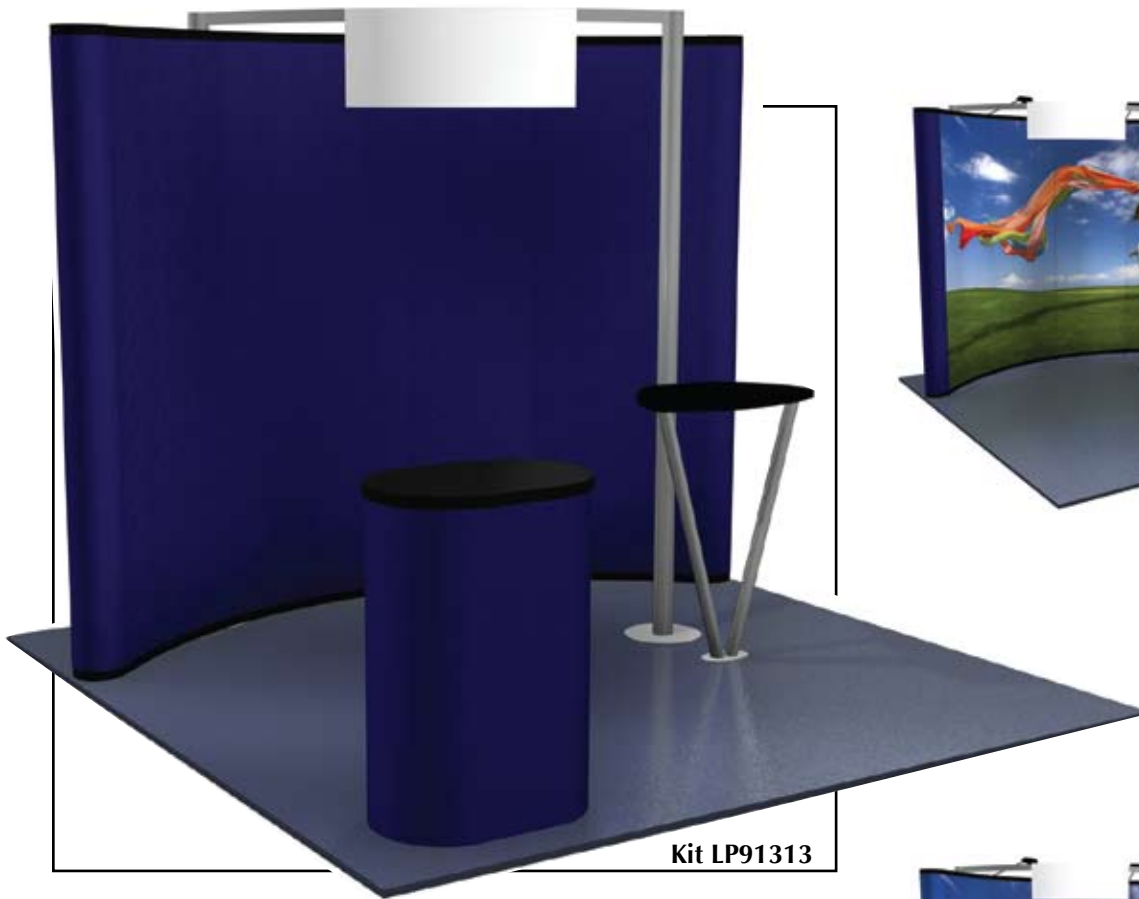

Kit LP91313



Kit: LP91313-C
Photo Mural &
Fabric Endcaps

Dimensions

10'w x 93"h x 66"d

Weight

166 lbs.

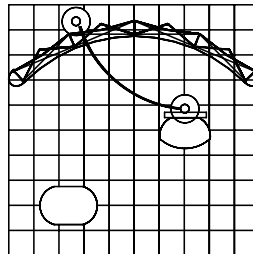

Kit: LP91313-CE
Full Photo Mural

Qty.	Part SKU#	Kit LP91313	Item Weight
1	LP4012	3x4 quad curved frame	10.00
7	LP2005	Connected channel bars	1.75
4	LP3103	Curved front fabric panels	4.00
2	LP3123	Fabric endcaps	3.00
2	LP8003	Halogen 150-watt lights	1.70
1	KIOSK91313	Aluminum Kiosk w/Monitor Mount, & V-Counter w/choice of laminate	60.00
1	WOC7003	Oval Case w/wheels & handle	22.00
1	WOC5301	Case-to-counter kit w/fabric wrap & black sintra inset	4.00
1	LZ0004	Wheeled Telescoping Flat Ship Case	32.00

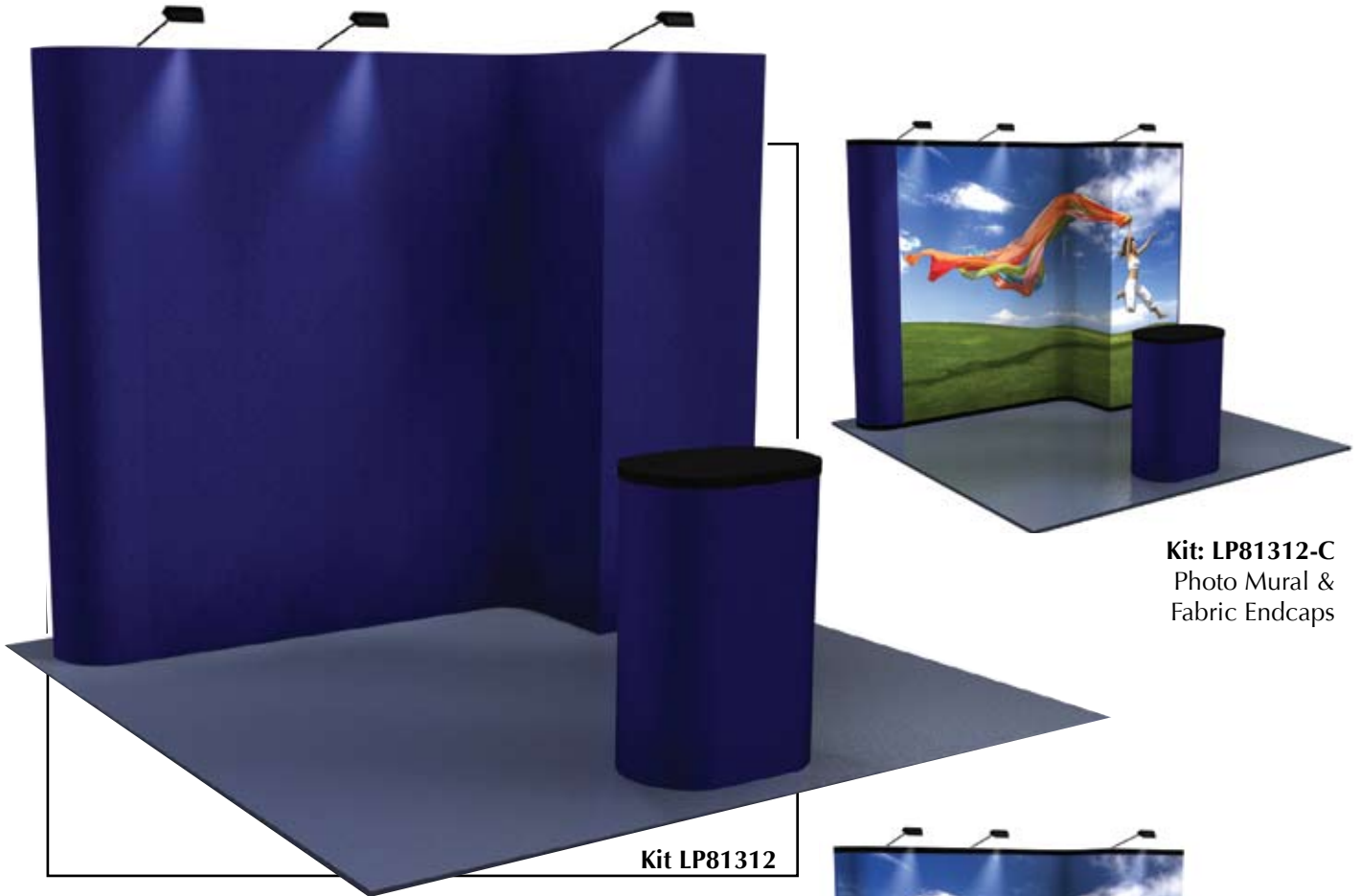

Kit: LP81312-C
Photo Mural & Fabric Endcaps

Kit LP81312

Dimensions **Weight**

 10'w x 93"h x 40" d 77 lbs.

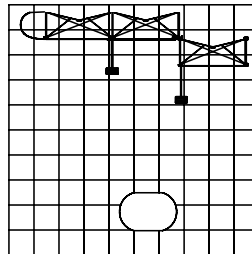

Kit: LP81312-CE
Full Photo Mural

Qty.	Part SKU#	Kit LP81312	Item Weight
1	LP4803T	3x1 straight tower frame	5.00
1	LP4806T	3x2 straight frame	6.00
7	LP2005	Connected channel bars	1.75
3	LP3803	Straight fabric panels	4.00
1	LP3823	Fabric endcaps	3.00
1	LP3875	Flat fabric endcap	
3.00			
1	LP3003L	Left-hinged connector panel	
5.00			
2	LP8003	Halogen 150-watt lights	1.70
1	WOC7003	Oval Case w/wheels & handle	22.00
1	WOC5301	Case-to-counter kit w/fabric wrap and black sintra inset	4.00

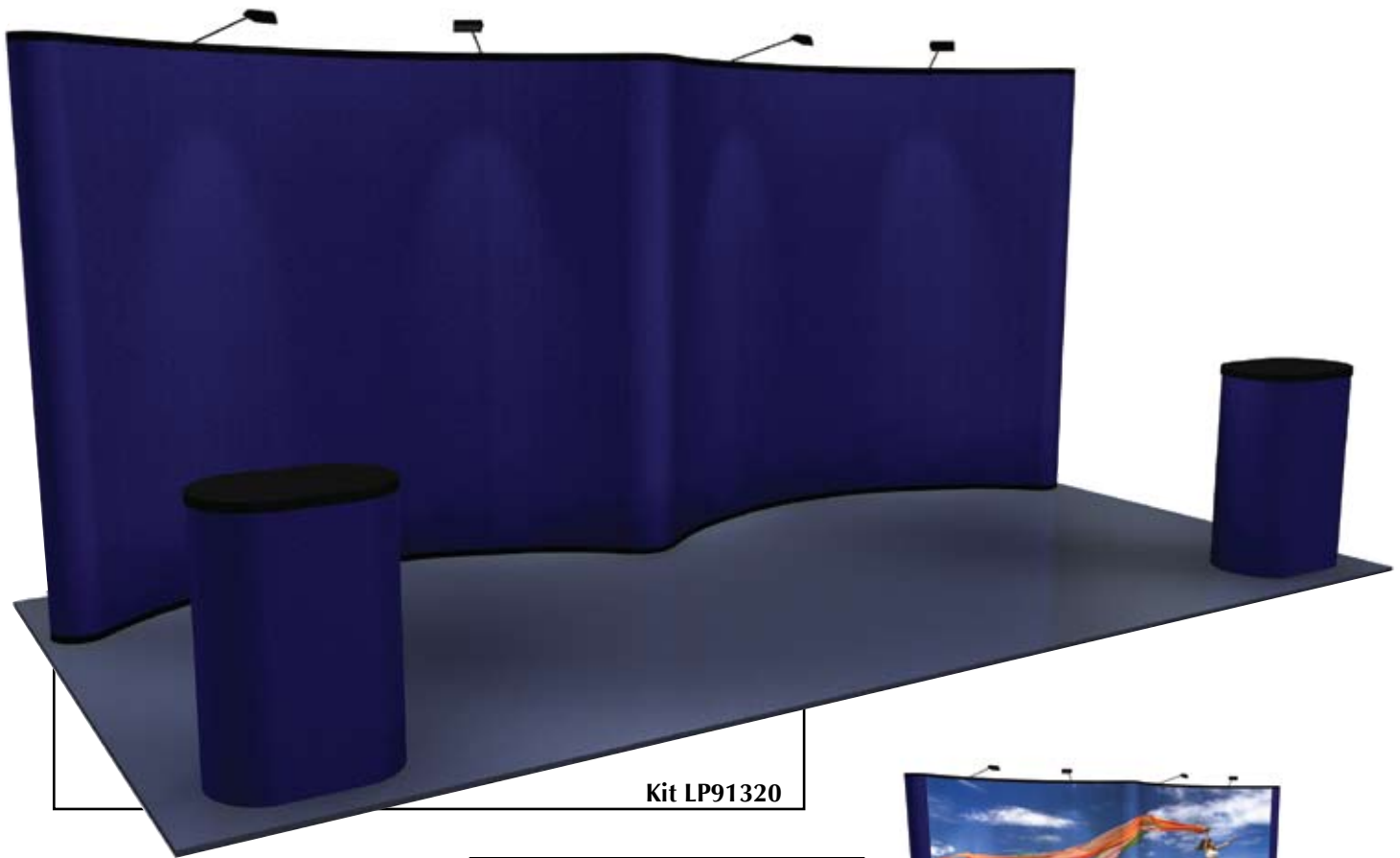

Kit LP91320

Dimensions

20'w x 93"h x 31"d

Weight

148 lbs.

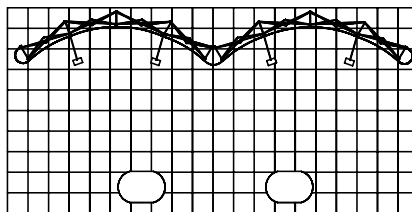

Kit: LP91320-C
Photo Mural & Fabric Endcaps

Qty.	Part SKU#	Kit LP91320	Item Weight
2	LP4012	3x4 quad curved frames	10.00
14	LP2005	Connected channel bars	1.75
8	LP3103	Curved front fabric panels	4.00
4	LP3123	Fabric endcaps	3.00
4	LP8003	Halogen 150-watt lights	1.70
2	WOC7003	Oval Case w/wheels & handle	22.00
2	WOC5301	Case-to-counter kit w/fabric wrap & black sintra inset	4.00



Kit: LP91320-CE
Full Photo Mural

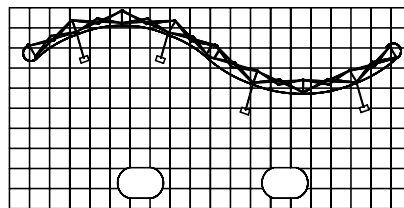
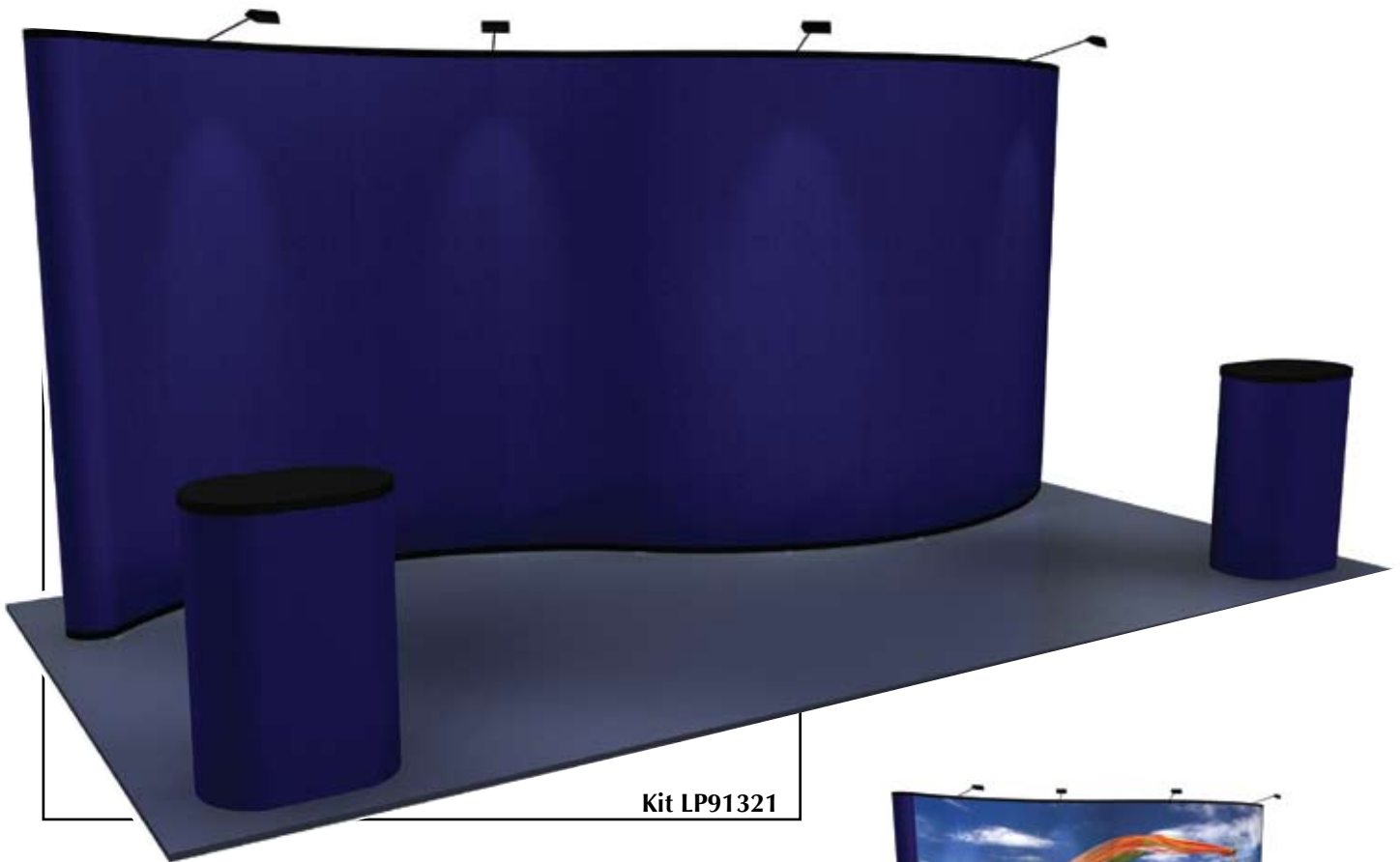

Dimensions

20'w x 93"h x 31"d

Weight

144 lbs.



Kit: LP91321-C
Photo Mural & Fabric Endcaps

Qty.	Part SKU#	Kit LP91321	Item Weight
2	LP4012	3x4 quad curved frames	10.00
12	LP2005	Connected channel bars	1.75
4	LP3103	Curved front fabric panels	4.00
4	LP3133	Back Fabric Panels	4.00
4	LP3123	Fabric endcaps	3.00
4	LP8003	Halogen 150-watt lights	1.70
2	WOC7003	Oval Case w/wheels and handle	22.00
2	WOC5301	Case-to-counter kit w/fabric wrap & black sintra inset	4.00



Kit: LP91321-CE
Full Photo Mural

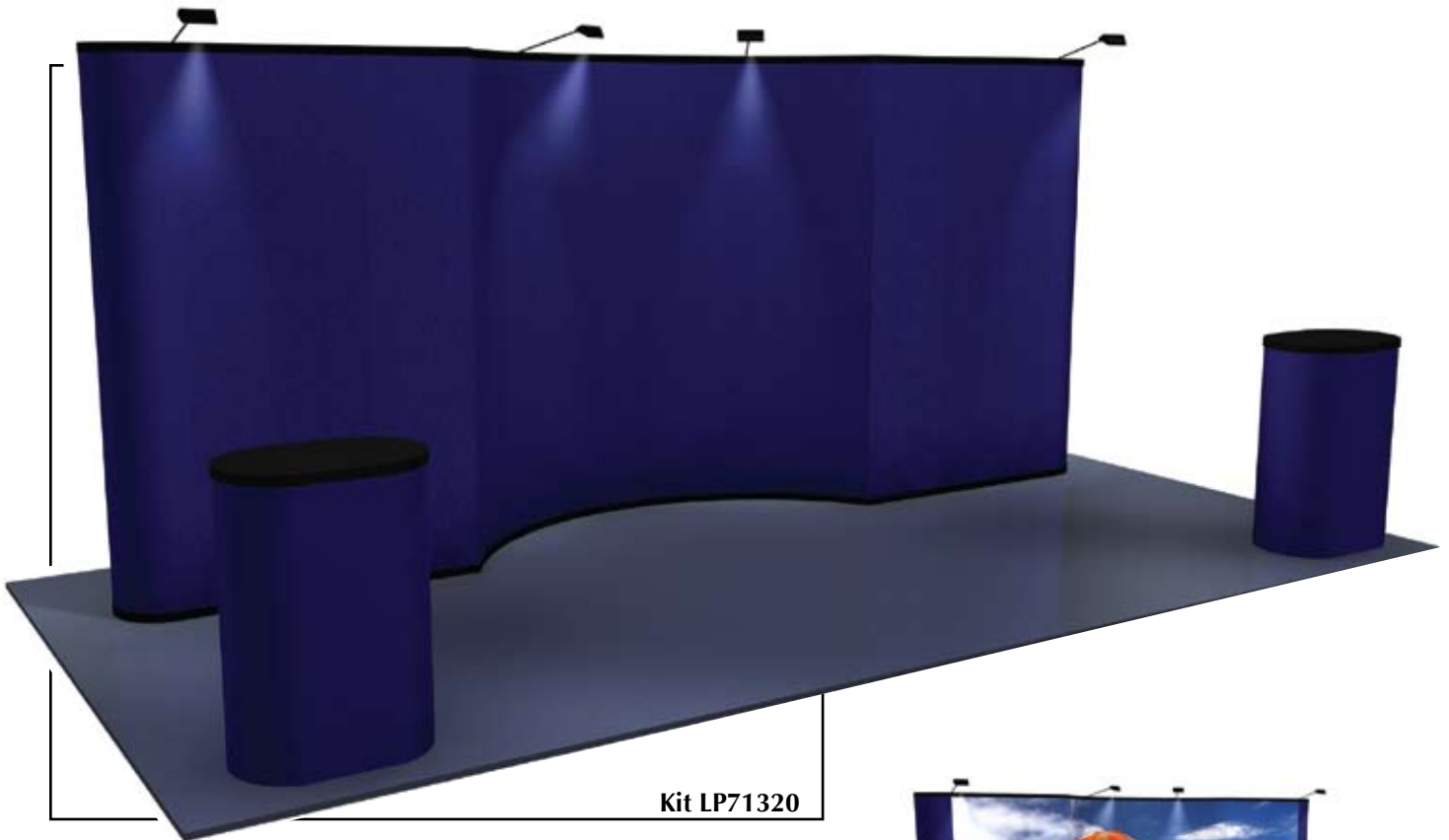

Kit LP71320

Dimensions

20'w x 93"h x 38"d

Weight

140lbs.

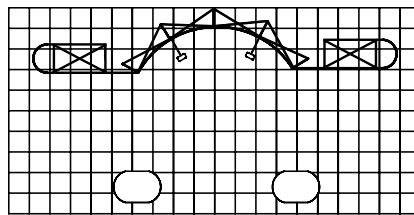

Kit: LP71320-C

Photo Mural & Fabric Endcaps

Qty.	Part SKU#	Kit LP71320	Item Weight
1	LP4012	3x4 quad curved frames	10.00
2	LP4803T	3x1 Quad straight frames	5.00
11	LP2005	Connected channel bars	1.75
4	LP3103	Curved front fabric panels	4.00
2	LP3803	Straight fabric panels	4.00
4	LP3123	Fabric endcaps	3.00
1	LP3003L	Left-hinged connector panel	3.00
1	LP3003R	Right-hinged connector panel	3.00
4	LP8003	Halogen 150-watt lights	1.70
2	WOC7003	Oval Case w/wheels & handle	22.00
2	WOC5301	Case-to-counter kit w/fabric wrap & black sintra inset	4.00



Curved Frames

Part SKU#	Description	Item Weight
LP4012	3x4 frame (10')	10 lbs.
LP4009	3x3 frame (8')	8 lbs.
LP4006	2x3 frame (8' ttop)	6 lbs.
LP4004	2x2 frame (6' ttop)	4 lbs.

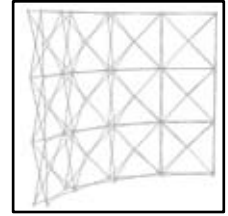

LP4012

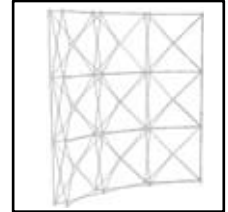

LP4009

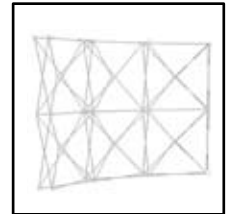

LP4006

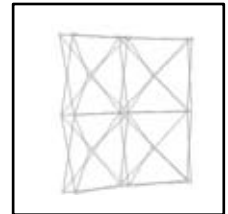

LP4004

Reduced Quad Frame

Part SKU#	Description	Item Weight
LPR4006	2x3 frame (reduced 8' ttop)	6 lbs.

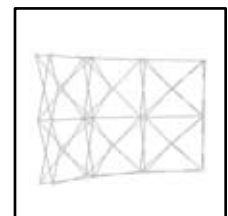

LPR4006

Straight Frame

Part SKU#	Description	Item Weight
LP4809	3x3 frame (10')	8 lbs.

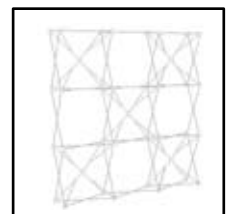

LP4809

Channel Bars

Part SKU#	Description	Item Weight
LP2004	2-piece channel bar	1.2 lbs.
LPR2004	2-piece reduced quad channel bar	1.2 lbs.
LP2005	3-piece channel bar	1.75 lbs.

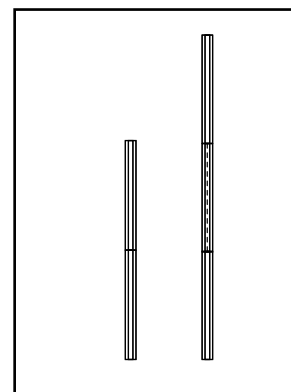

Channel Bars

Stiffeners - Curved Frame

Part SKU#	Description
LP2011	Front curve stiffener set – (top & bottom)
LP2011B	Back curve stiffener set – (top & bottom)
LP2012	Round curve stiffener endcap set – (top & bottom)
LP2012F	Flat stiffener endcap set for curved frame–(top & bottom)
LPR2011	Reduced Quad front curve stiffener set - (top & bottom)
LPR2011B	Reduced Quad back curve stiffener set - (top & bottom)
LPR2012	Reduced Quad endcap stiffener set - (top & bottom)

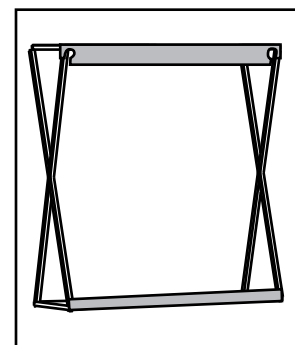

Stiffeners

Stiffeners - Straight Frame

Part SKU#	Description
LP2013	Stiffener set for straight frame
LP2014	Round stiffener endcap set for straight frame
LP2014F	Flat stiffener endcap set for straight frame

Magnets

Part SKU#	Description
A-LP2016	B-Magnet for channel bars (100ft/per roll)
B-LP2017	A-Magnet for Panels (100ft/per roll)

Panels

Part SKU#	Description	Item Weight
LP3103	Front panel – 3 quad high	4 lbs.
LP3102	Front panel – 2 quad high	3 lbs.
LP3133	Back panel – 3 quad high	4 lbs.
LP3803	Panels Straight Frame	4 lbs.

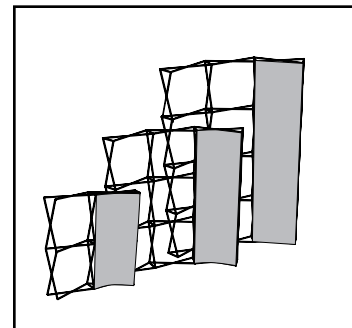

Curved Panels

Panels - reduced quad

Part SKU#	Description	Item Weight
LPR3102	Front panel – 2 quad high reduced	4 lbs.
LPR3122	End panel – 2 quad high reduced	3 lbs.

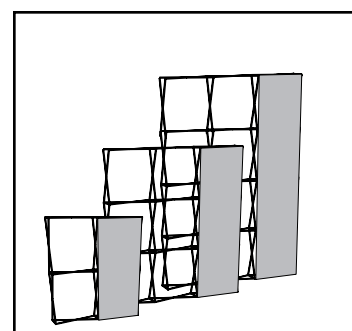

Flat Panels

End Caps - Curved Frame

Part SKU#	Description	Item Weight
LP3123	Round end cap – 3 quad high	3 lbs.
LP3122	Round end cap – 2 quad high	2 lbs.
LP3173	Flat end cap for curved frame – 3 quad high	3 lbs.

End Caps - Straight Frame

Part SKU#	Description	Item Weight
LP3123	Round end cap – 3 quad high	3 lbs.
LP3122	Round end cap – 2 quad high	2 lbs.
LP3173	Flat end cap for curved frame – 3 quad high	3 lbs.

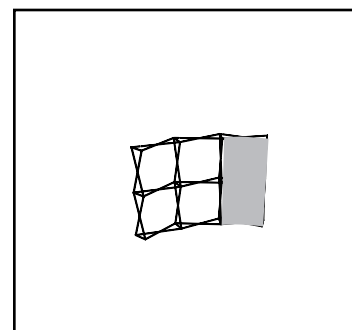

Reduced Quad Panels

Connector Panels

Part SKU#	Description	Item Weight
LP3873	Flat end cap for straight frame – 3 quad high	3 lbs.
LP3823	Round end cap – 3 quad high	2 lbs.

Connector Panels

Part SKU#	Description	Item Weight
WOC5304	Oval fabric case wrap	3 lbs.

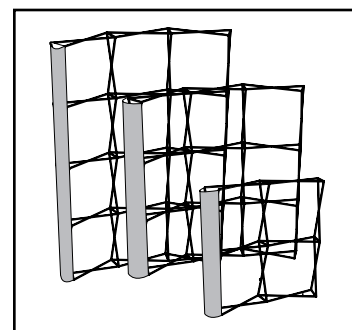

End Panels

Shelving

Part SKU#	Description	Item Weight
LP5501	Premium Shelf Package	2 lbs.
LP5521	Replacement Shelf	1.5 lbs.
LP5511	Replacement Bracket-pair	0.5 lbs.

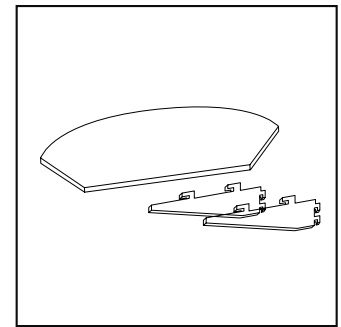

LP5501

Headers

Part SKU#	Description	Item Weight
LP6010	10' Back-lit Header Kit Kit includes: PU0010 10' header frame (1) 30030 light bars w/ 3 bulbs (2) 31030 multi outlet strip (1) magnetic tape Dim: 14"h x 96"l	10.5 lbs.

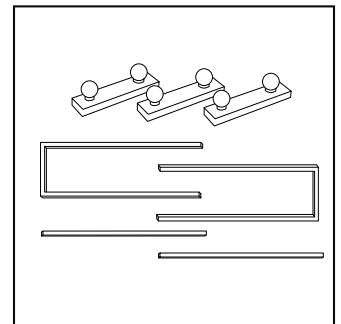

LP6010

Lighting

Part SKU#	Description	Item Weight
LP8003	Halogen Light 150-watt	1.7 lbs.
31070	Par 20 75-watt halogen (Vegas Friendly)	1.5 lbs.

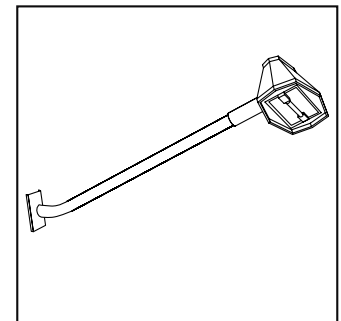

LP8003

Shipping Cases

Part SKU#	Description	Item Weight
WOC7003	Oval case with wheels	22 lbs.
WSC7001	Square Case with wheels	20 lbs.
LZ0004	Flat Packing Case	24 lbs.

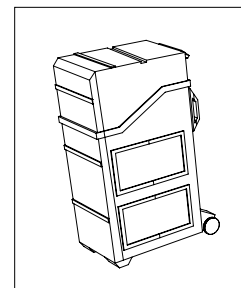

WSC7001

Replacement Case Parts

Part SKU#	Description
7003WK	Wheel replacement kit – oval case
7001WK	Wheel replacement kit – square case
7003LA	Latch assembly – oval case
7001LA	Latch assembly – square case

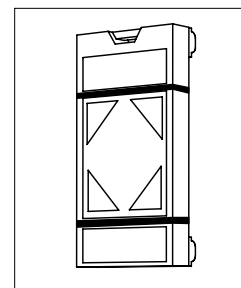

LZ0004

Case Accessories

Part SKU#	Description	Item Weight
WOC5303	Sintra inset (black)	1.5lbs.
WOC5302	Laminated countertop	5 lbs.
WOC5304	Oval fabric case wrap	3 lbs.
WOC5301	Oval case-to-counter kit (fabric wrap & black sintra inset)	4 lbs.
WOC5300	Upgraded oval case-to-counter kit (laminated countertop & fabric wrap)	8 lbs.
LPGCCW	Direct Print case wrap	8 lbs.

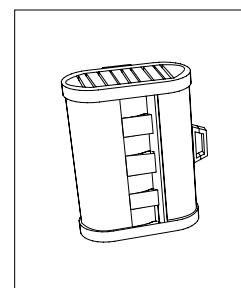

WOC7003

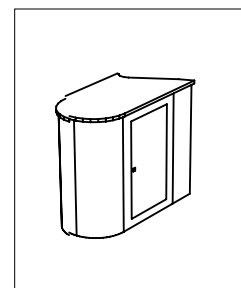

PC009

Counters

Part SKU#	Description	Item Weight
PC0008	Left-curved Peninsula Counter w/storage door*	53 lbs.
PC0009	Right-curved Peninsula Counter w/storage door* *Price includes flat packing case	53 lbs.

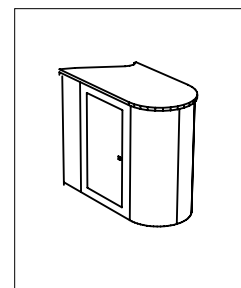

PC008